



SSD : SLIM SURFACE DOWNLIGHT

DESCRIPTION

The SSD Slim Surface Downlight is a recessed downlight suitable for new construction and remodeling applications. It features uniform light distribution, Triac dimming, and optional colored trim rings to customize the look of the fixture.

FEATURES

- Replaces legacy 6", 8", or 9" CFL or incandescent downlights
- 9" features emergency battery backup
- Provides comfortable diffused light with no dark spots
- Dimmable to 10% with compatible Triac dimmers

LISTINGS

- ETL Listed for Damp Locations
- ENERGY STAR® Approved for superior energy efficiency

PERFORMANCE

- 3000K or FieldCCeT
- FieldCCeT option lets user choose between 2700K/3000K/4000K prior to installation
- CRI: >80 or >90

ELECTRICAL

- Input voltage: 120V
- Triac dimming (6" and 8" models)

CONSTRUCTION

- Frosted lens for diffuse lighting

WARRANTY

- 5 year limited warranty; see eiko.com for warranty details

project name	type
catalog number	
comments	voltage
approved by	date



with Emergency Battery Backup

APPLICATIONS

- Residential
- Multi-family
- Hospitality
- Office
- Property management
- Healthcare
- Retail



ORDERING INFORMATION

EXAMPLE: SSD6-84-12W-830-120DT-WH

Model	Size	Lumens	Watts	CRI/CCT	Voltage	Dimming	Finish	Options
SSD : Slim Surface Downlight	6 - 6"	84 - 840 lm	12W - 12W	830 - 80 CRI; 3000K 9CCT3 - 90 CRI; 27/30/4000K	120 - 120V	DT - Triac Dimming	WH - White	EM - Emergency Battery Backup
	8 - 8"		18W - 18W	830 - 80 CRI; 3000K 9CCT3 - 90 CRI; 27/30/4000K				
	9 - 9"	126 - 1,260 lm		930 - 90 CRI; 3000K	UNV - 120-277V	[Non-Dim]		

PERFORMANCE SUMMARY

Order Code	Item #	Size	Watts	Lumens	CCT	CRI	Volts	Dimming	ES
11285	SSD6-84-12W-830-120DT-WH	6"	12W	840 lm	3000K	80+	120-277V	Triac	★
11286	SSD8-126-18W-830-120DT-WH	8"	18W	1,260 lm	3000K	80+	120-277V	Triac	★
11287	SSD6-84-12W-9CCT3-120DT-WH	6"	12W	840 lm	27/30/4000K	90+	120-277V	Triac	★
11288	SSD8-126-18W-9CCT3-120DT-WH	8"	18W	1,260 lm	27/30/4000K	90+	120-277V	Triac	★
11313	SSD9-126-18W-930-UNV-WH-EM	9"	18W	1,260 lm	3000K	90+	120-277V	Non-dimming	★

ACCESSORIES (9CCT3 versions only)

Order Code	Item #	Description
11289	SSD6-TRIM-BK*	6" Trim Black
11308	SSD6-TRIM-CH*	6" Trim Chrome
11309	SSD6-TRIM-NI*	6" Trim Nickel
11310	SSD8-TRIM-BK †	8" Trim Black
11311	SSD8-TRIM-CH †	8" Trim Chrome
11312	SSD8-TRIM-NI †	8" Trim Nickel

*Only for use with SSD6-84-12W-9CCT3-120DT-WH

†Only for use with SSD8-126-18W-9CCT3-120DT-WH

DIMENSIONS

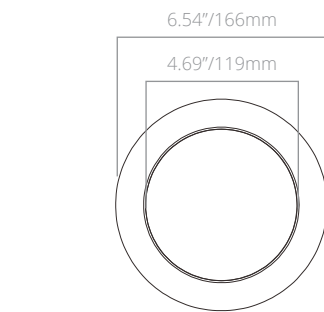

6" Trim Ring

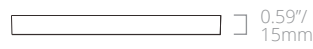
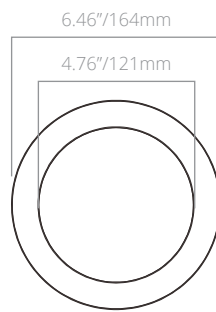

6" SDL Fixture

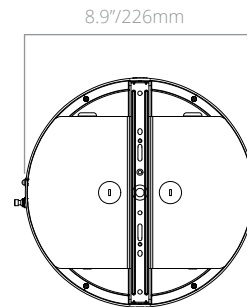

9" SDL Fixture

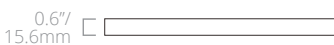
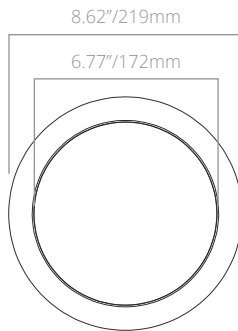

8" Trim Ring

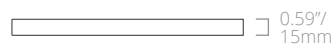
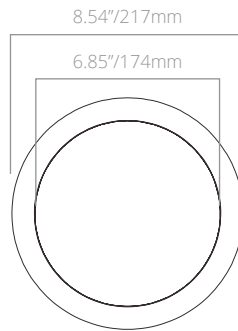

8" SDL Fixture