



HID LED HID Replacement

FEATURES

- LED replacement for high wattage HID fixtures from 50W to 600W
- Universal mounting position
- Lasts 3x longer than metal halide or HPS HID lamps
- FieldCCeT feature allows for multiple “set and forget” CCT options
- Eliminates maintenance costs for over 10 years; no expensive HID lamps or ballasts to replace
- Shatter resistant for reduced risk of injury or breakage
- Integral driver; eliminates the need for external driver or ballast
- Environmentally friendly: contains no glass, mercury, or lead
- Built-in surge protection

WARRANTY

- 5 year limited warranty. Additional warranty options available. Contact EiKO for details

APPLICATIONS

- Gyms & Athletic Facilities
- Production Areas
- Shipping/Receiving
- Warehouses
- Exterior Perimeter
- Parking Garage
- Parking Lot

project name	type
catalog number	voltage
approved by	date



**SMALL
STANDARD**



**MEDIUM
STANDARD**



**MEDIUM
FIELDCCET**



**LARGE
STANDARD**

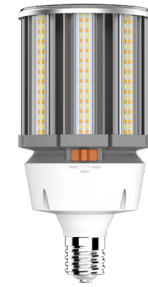

**LARGE
FIELDCCET**

PERFORMANCE	Power Consumption	15W, 19W, 24W, 27W, 36W, 45W, 54W, 63W, 80W, 100W, 120W
	Lumens	1,950 - 16,000
	Replace HID	50W, 70W, 100W, 125W, 150W, 175W, 200W, 320W, 400W, 600W
	CRI	>80
	Beam	Omnidirectional
	CCT	3000K, 4000K, 5000K, 30/40/5000K FieldCCeT
	Life (L70)	50,000 hours
ELECTRICAL	Power Factor	≥0.9
	Input Voltage	100-277V, 277-480V
CONSTRUCTION	Operating Temperature	Small: -40°F to 140°F (-40°C to 60°C); Medium and FieldCCeT: -40°F to 140°F (-40°C to 60°C); Large: -4°F to 113°F (-20°C to 45°C); Large 277-480V models: -40°F to 113°F (-40°C to 45°C)
	Enclosed Temperature	-4°F to 104°F (-20°C to 40°C)
	Base	E26; EX39
LISTINGS	Certification(s)	DesignLights Consortium® Qualified; cULus Classified; FCC
	Material Usage	RoHS Compliant; no mercury
	Environment	IP64 Rated; Suitable for use in enclosed fixtures



PERFORMANCE SUMMARY

ORDER CODE	ITEM #	WATTS	LUMENS	LPW	CCT	CRI	VOLTS	BASE	LIFE HOURS	REPLACE HID	FIELD CCET	SENSOR READY	DLC STANDARD
SMALL : 15W-24W													
09632	LED15WPT30KMED-G7*	15W	1,875	125	3000K	>80	100-277V	E26	50,000	50W			
09390	LED15WPT40KMED-G7*	15W	1,875	125	4000K	>80	100-277V	E26	50,000	50W			
09391	LED15WPT50KMED-G7*	15W	1,950	130	5000K	>80	100-277V	E26	50,000	50W			
09633	LED19WPT30KMED-G7*	19W	2,375	125	3000K	>80	100-277V	E26	50,000	70W			
09392	LED19WPT40KMED-G7*	19W	2,375	125	4000K	>80	100-277V	E26	50,000	70W			
09393	LED19WPT50KMED-G7*	19W	2,470	130	5000K	>80	100-277V	E26	50,000	70W			
09634	LED24WPT30KMED-G7	24W	3,000	125	3000K	>80	100-277V	E26	50,000	100W			
MEDIUM : 27W-63W													
10228	LED27WPT30KMED-G8	27W	3,650	135	3000K	>80	100-277V	E26	50,000	125W			
10233	LED36WPT30KMED-G8	36W	4,850	135	3000K	>80	100-277V	E26	50,000	150W			
10238	LED36WPT40KMED-G8	36W	5,000	139	4000K	>80	100-277V	E26	50,000	150W			
10240	LED36WPT50KMED-G8	36W	5,200	144	5000K	>80	100-277V	E26	50,000	150W			
12050	LED36WPT40KMED-V-G9	36W	5,400	150	4000K	>80	277-480V	E26	50,000	150W			
12051	LED36WPT50KMED-V-G9	36W	5,400	150	5000K	>80	277-480V	E26	50,000	150W			
10242	LED45WPT30KMED-G8	45W	6,100	136	3000K	>80	100-277V	E26	50,000	175W			
10244	LED45WPT40KMED-G8	45W	6,300	140	4000K	>80	100-277V	E26	50,000	175W			
10246	LED45WPT50KMED-G8	45W	6,500	144	5000K	>80	100-277V	E26	50,000	175W			
10248	LED54WPT30KMED-G8	54W	7,300	135	3000K	>80	100-277V	E26	50,000	200W			
10250	LED54WPT40KMED-G8	54W	7,550	140	4000K	>80	100-277V	E26	50,000	200W			
10252	LED54WPT50KMED-G8	54W	7,800	144	5000K	>80	100-277V	E26	50,000	200W			
10227	LED27WPT30KMOG-G8	27W	3,650	135	3000K	>80	100-277V	EX39	50,000	125W			✓
10230	LED27WPT40KMOG-G8	27W	3,750	138	4000K	>80	100-277V	EX39	50,000	125W			✓
10232	LED27WPT50KMOG-G8	27W	3,900	144	5000K	>80	100-277V	EX39	50,000	125W			✓
10237	LED36WPT30KMOG-G8	36W	4,850	135	3000K	>80	100-277V	EX39	50,000	150W			✓
10239	LED36WPT40KMOG-G8	36W	5,000	139	4000K	>80	100-277V	EX39	50,000	150W			✓
10241	LED36WPT50KMOG-G8	36W	5,200	144	5000K	>80	100-277V	EX39	50,000	150W			✓
12052	LED36WPT40KMOG-V-G9	36W	5,400	150	4000K	>80	277-480V	EX39	50,000	150W			✓
12053	LED36WPT50KMOG-V-G9	36W	5,400	150	5000K	>80	277-480V	EX39	50,000	150W			✓
11423	LED36WPTCCTMED-G8	36W	4,800	133	30/40/5000K	>80	120-277V	E26	50,000	150W	●	■	
11424	LED36WPTCCTMOG-G8	36W	4,800	133	30/40/5000K	>80	120-277V	EX39	50,000	150W	●	■	✓
10243	LED45WPT30KMOG-G8	45W	6,100	136	3000K	>80	100-277V	EX39	50,000	175W			✓
10245	LED45WPT40KMOG-G8	45W	6,300	140	4000K	>80	100-277V	EX39	50,000	175W			✓
10247	LED45WPT50KMOG-G8	45W	6,500	144	5000K	>80	100-277V	EX39	50,000	175W			✓
11425	LED45WPTCCTMED-G8	45W	6,100	136	30/40/5000K	>80	120-277V	E26	50,000	175W	●	■	
11426	LED45WPTCCTMOG-G8	45W	6,100	136	30/40/5000K	>80	120-277V	EX39	50,000	175W	●	■	✓
10249	LED54WPT30KMOG-G8	54W	7,300	135	3000K	>80	100-277V	EX39	50,000	200W			✓
10251	LED54WPT40KMOG-G8	54W	7,550	140	4000K	>80	100-277V	EX39	50,000	200W			✓
10253	LED54WPT50KMOG-G8	54W	7,800	144	5000K	>80	100-277V	EX39	50,000	200W			✓
12054	LED54WPT40KMOG-V-G9	54W	8,100	150	4000K	>80	277-480V	EX39	50,000	200W			✓
12055	LED54WPT50KMOG-V-G9	54W	8,100	150	5000K	>80	277-480V	EX39	50,000	200W			✓
11427	LED54WPTCCTMED-G8	54W	7,250	134	30/40/5000K	>80	120-277V	E26	50,000	200W	●	■	
11428	LED54WPTCCTMOG-G8	54W	7,250	134	30/40/5000K	>80	120-277V	EX39	50,000	200W	●	■	✓
11429	LED63WPTCCTMOG-G8	63W	8,500	135	30/40/5000K	>80	120-277V	EX39	50,000	300W	●	■	✓
LARGE : 80W-120W													
10260	LED80WPT40KMOG-G8	80W	10,400	130	4000K	>80	100-277V	EX39	50,000	320W			✓
10261	LED80WPT50KMOG-G8	80W	10,400	130	5000K	>80	100-277V	EX39	50,000	320W			✓
11430	LED80WPTCCTMOG-G8	80W	11,000	138	30/40/5000K	>80	120-277V	EX39	50,000	320W	●	■	✓
12056	LED100WPT40KMOG-V-G9	100W	15,000	150	4000K	>80	277-480V	EX39	50,000	400W			✓
12057	LED100WPT50KMOG-V-G9	100W	15,000	150	5000K	>80	277-480V	EX39	50,000	400W			✓
10254	LED100WPT30KMOG-G8	100W	13,000	130	3000K	>80	100-277V	EX39	50,000	400W			✓
10255	LED100WPT40KMOG-G8	100W	13,000	130	4000K	>80	100-277V	EX39	50,000	400W			✓
10256	LED100WPT50KMOG-G8	100W	13,000	130	5000K	>80	100-277V	EX39	50,000	400W			✓
11431	LED100WPTCCTMOG-G8	100W	13,500	135	30/40/5000K	>80	120-277V	EX39	50,000	400W	●	■	✓
10258	LED120WPT40KMOG-G8	120W	15,600	130	4000K	>80	100-277V	EX39	50,000	600W			✓
10259	LED120WPT50KMOG-G8	120W	15,600	130	5000K	>80	100-277V	EX39	50,000	600W			✓
11432	LED120WPTCCTMOG-G8	120W	16,000	133	30/40/5000K	>80	120-277V	EX39	50,000	600W	●		✓

*NOTE: These products do not meet CEC Title 20 requirements and are not to be sold in the state of California, except when sold wholesale for final retail sale outside CA.

PLUG-IN SENSORS

ORDER CODE	ITEM #	DESCRIPTION
10910	PT-SEN/PIR	LED HID Replacement Lamp Sensor PIR 3.5mm Plug w/PC
10911	PT-SEN/PC	LED HID Replacement Lamp Sensor PC 3.5mm Plug



PIR SENSOR



PC SENSOR

PRODUCT DIMENSIONS

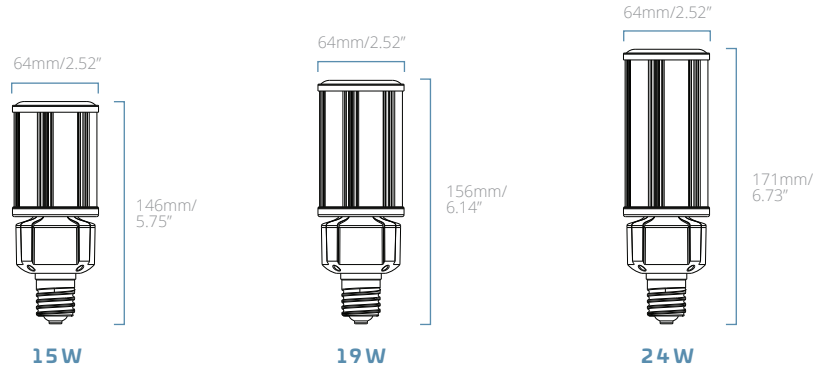

SMALL G7

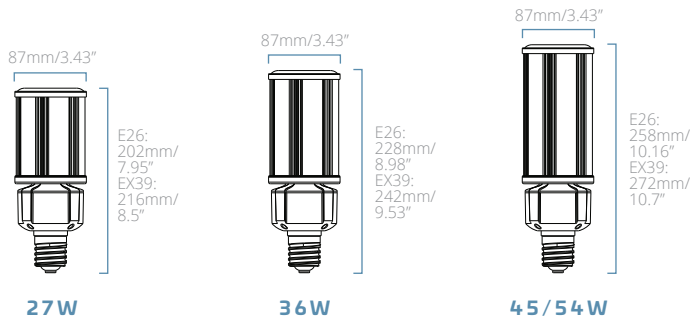

MEDIUM G7

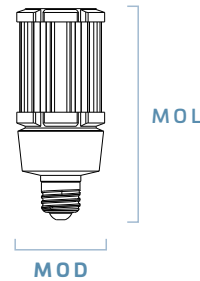

SIZE (WATTS)	MOL	MOD
27W	E26: 6.69"/170mm EX39: 7.28"/185mm	2.36"/60mm
36W	E26: 7.95"/202mm EX39: 8.7"/221mm	3.35"/85mm
45/54W	E26: 9.13"/232mm EX39: 9.88"/251mm	3.35"/85mm

MEDIUM G8

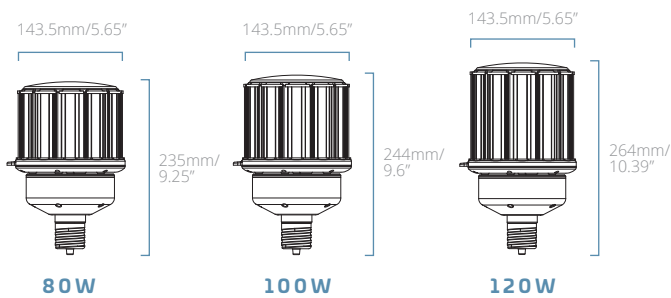

LARGE G7

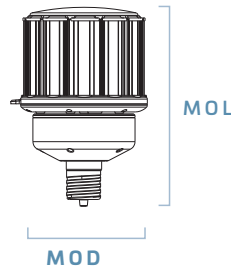

SIZE (WATTS)	MOL	MOD
80W	9.21"/234mm	5.87"/149mm
100W	9.57"/243mm	5.87"/149mm
120W	10.35"/263mm	5.87"/149mm

LARGE G8

PRODUCT DIMENSIONS

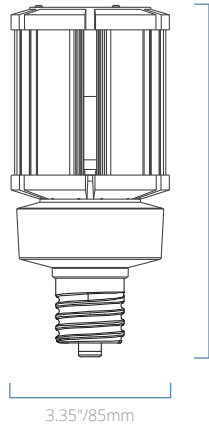

36W

E26:
7.76\"/>

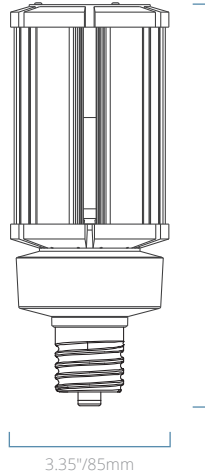

54W

9.88\"/>

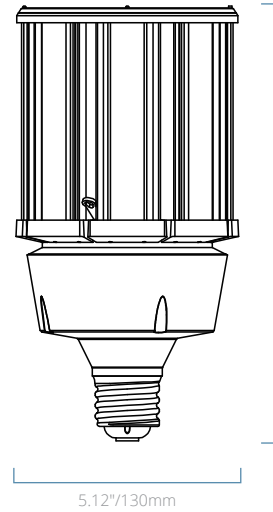

100W

10.43\"/>

HIGH VOLTAGE G9

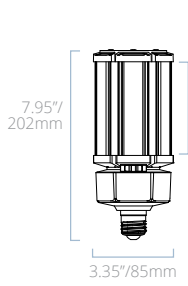

36W E26

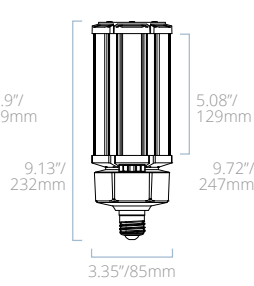

45/54W E26

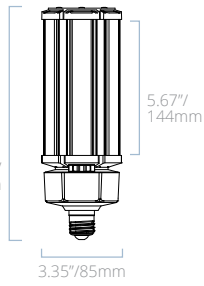

63W E26

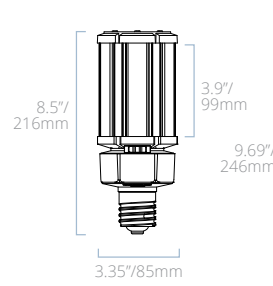

36W EX39

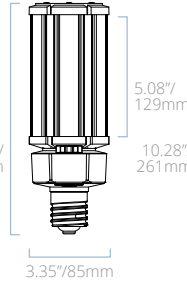

45/54W EX39

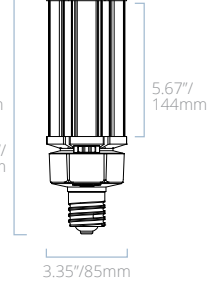

63W EX39

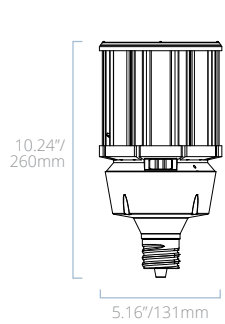

80W EX39

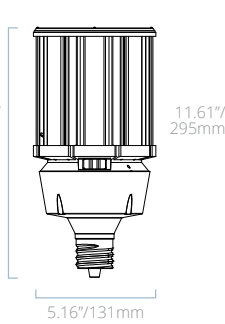

100W EX39

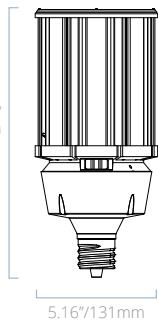

120W EX39

FIELDCCET